

THETFORD



Porta Potti Campa Potti

User Manual

QUICK GUIDE

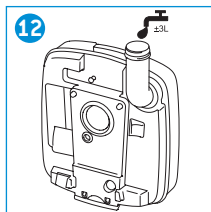
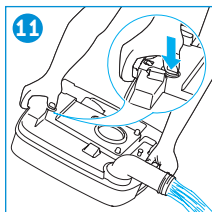
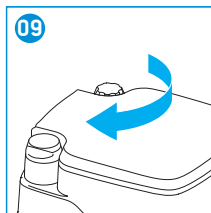
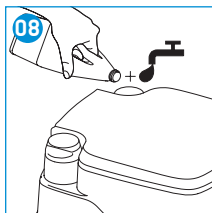
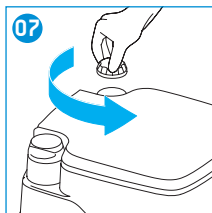
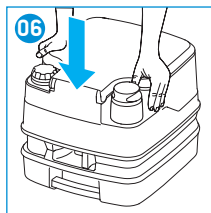
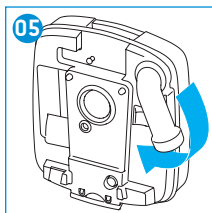
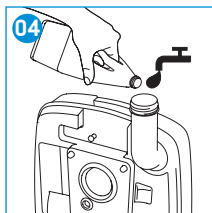
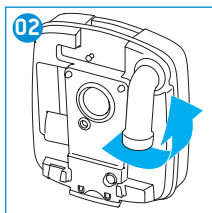
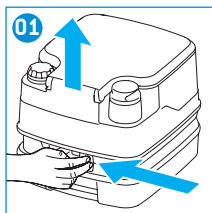

QUICK GUIDE

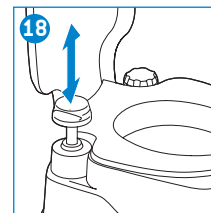
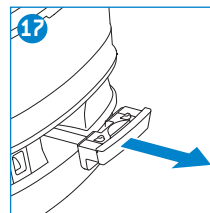
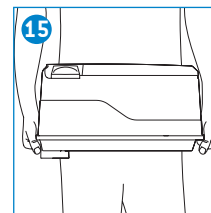
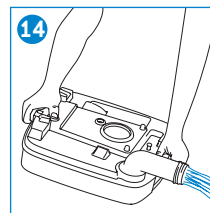
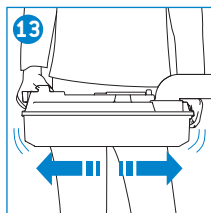

Main parts

A

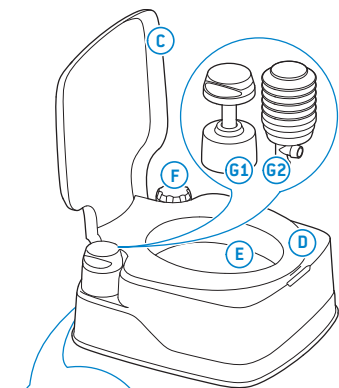

A Flush-water tank

- C Cover
- D Seat
- E Toilet bowl
- F Water fill cap
- G1 Piston pump
- G2 Bellow pump
- H Clasp

B

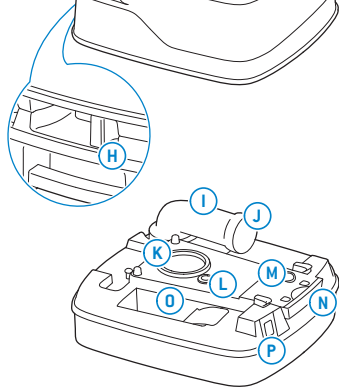

B Waste-holding tank

- I Pour out spout
- J Cap pour out spout
- K Lip seal
- L Vent seal
- M Vent button
- N Valve handle
- O Storage for toilet fluids
- P Level indicator waste-holding tank (dependent on model)

Optional extra for your toilet

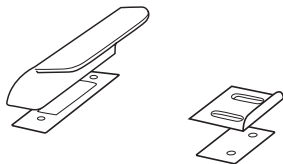

Hold down kit

This allows you to attach the toilet to the floor, wherever you like. One simple action releases the toilet (standard for 335 model, optional extra for other models).

1. Introduction

This is the user manual for your Thetford portable toilet. Read the safety instructions and information on use and maintenance of the toilet carefully before continuing. This will enable you to use the toilet safely and efficiently. Retain this manual for future reference.

For the latest version of this manual, please visit www.thetford.com

2. Symbols

Key to symbols:

Warning. Risk of serious injury and/or damage.

Caution. Risk of injury and/or damage.

Attention. Important information.

Note. Information.

3. Before use

See the images in the 'Quick Guide' at the front of the manual for a visual reference [p 2-3].

Your portable toilet is made up of two detachable sections: the flush-water tank (A) and the waste-holding tank (B). Before using the toilet, it is vital that you add toilet additives (where available) to both tanks.

Not using the correct products to care for your Thetford toilet could cause damage.

Thetford offers a wide range of toilet additives and care products. Look on the flyer for the variety of all products.

Prepare the waste-holding tank (B):

- Separate tanks (01).
- Remove the cap from the pour out spout while it is pointing upwards (02/03).
- Add the correct dosage of waste-holding tank toilet additive (04).
- Add the correct dosage of water to ensure that the bottom of the waste-holding tank is covered (04).
- Replace the cap (05).

Never add toilet additives directly via the blade as this could damage the lip seal of the waste-holding tank. Only fill the waste-holding tank via the pour out spout.

Prepare the flush-water tank (A):

- Recombine tanks (06).
- Remove the water fill cap (07).
- Add the correct dosage of flush-water tank toilet additive (where available) and fill the flush-water tank with clean water (08).
- Replace the cap (09).

4. Use of the toilet

See the indicated Quick Guide images for visual reference.

To vent any built-up heat or altitude pressure and prevent for splashing close the cover and once open and close the blade.

Opening the blade

The toilet can be used with the blade open or closed. To open the blade, pull the blade handle (47).

Make sure you always close the blade completely after use.

Flushing the toilet

You can achieve the most effective flush by operating the manual pump with three or four short flushes (48).



Do not use ordinary toilet paper, as this may cause clogging.



To prevent water damage to your caravan or motor home, do not travel with a waste-holding tank that is more than 3/4 full. This may cause leakage through the venting system.



To prevent water damage to your caravan or motor home, do not travel with water in the toilet bowl.



To prevent water damage to your caravan or motor home, do not travel with a flush-water tank that is too full. Thetford advises travelling with an empty flush-water tank, but at least not filled more than half-ful.



The toilet can withstand a maximum load of 120kg (265 lbs). Make sure you do not overload the toilet.

5. Emptying the tanks

See the indicated Quick Guide images for visual reference.

If you want to continue using your toilet after emptying, prepare the waste-holding tank again.

Waste-holding tank

You need to empty the waste-holding tank when the level indicator turns red.

- Separate the tanks (01).
- Take the waste-holding tank to an authorised waste disposal point (10).
- Remove the cap from the pour out spout, while it is pointing upwards (03).
- Press and hold the vent button with your thumb while the pour out spout is pointing downwards to empty the waste-holding tank without splashing (11).
- Rinse the tank (12/13/14).
- Recombine the tanks (06).



Do not allow the waste-holding tank to become too full.

Flush-water tank

Only empty the flush-water tank completely if you expect not to use your toilet for a long period.

- Remove the water fill cap (07).
- Empty the flush-water tank through the water fill opening (45).
- Flush the toilet until no more water is being pumped out (18).



Emptying is only allowed at an authorised waste dump.



To vent the flush-water tank the water fill cap contains a small vent hole. Fresh water can come through when lifting or positioning the toilet under an angle.

6. Maintenance and cleaning

Thetford recommends cleaning your toilet regularly to prevent limescale and ensure optimal hygiene.

- Clean the inside of the bowl with a soft brush and a special cleaning product.
- Clean the complete toilet with special cleaning products.



Never use household cleaners to clean your portable toilet. These may cause permanent damage to the seals and other toilet components.

Also maintain your toilet regularly to prolong the lifespan of your toilet.

- Clean the inside of the waste-holding tank 2 to 3 times a year to remove stubborn limescale.
- Treat the seals with special lubricant to keep the seals soft and pliable.



Never use Vaseline or vegetable oil to lubricate the seals. This may cause leakage to your waste-holding tank.



Thetford offers a wide range of toilet additives and care products. Look on the flyer for the variety of all products.



The valve blade seal is a part of the toilet that is subject to wear.

Depending on the extent and manner of servicing, after a certain period the seal will lose quality and must be replaced.

7. Winter use

You can use your toilet as normal in cold weather as long as the toilet is situated in a heated location. If this is not the case, and there is a risk of frost, we advise not to use your toilet. Make sure you completely drain the toilet. Then empty the waste-holding tank and the flush-water tank, see Putting in storage.

8. Putting in storage

- Empty the flush-water tank.
- Flush the toilet until no more water is being pumped out.
- Empty the waste-holding tank.
- Thoroughly clean and dry the whole toilet.
- Open the blade and loosen the cap of the pour out spout to ventilate the waste-holding tank.
- Loosen the water fill cap to ventilate the flush-water tank.

We recommend maintaining your toilet before putting it into storage. See Maintenance and cleaning.

9. Disposal

Your product has been designed and manufactured with high quality materials and components, which can be recycled and reused. When your product has reached its end of life, dispose of the product according to the local rules. Do not dispose of the product with the normal household waste. The correct disposal of your old product will help prevent potential negative consequences to the environment and human health.